

CWI LIGHTING

BRIGHTER LIVING. SIMPLIFIED.

PROJECT: _____

FIXTURE TYPE: _____

LOCATION: _____

CONTACT/PHONE: _____

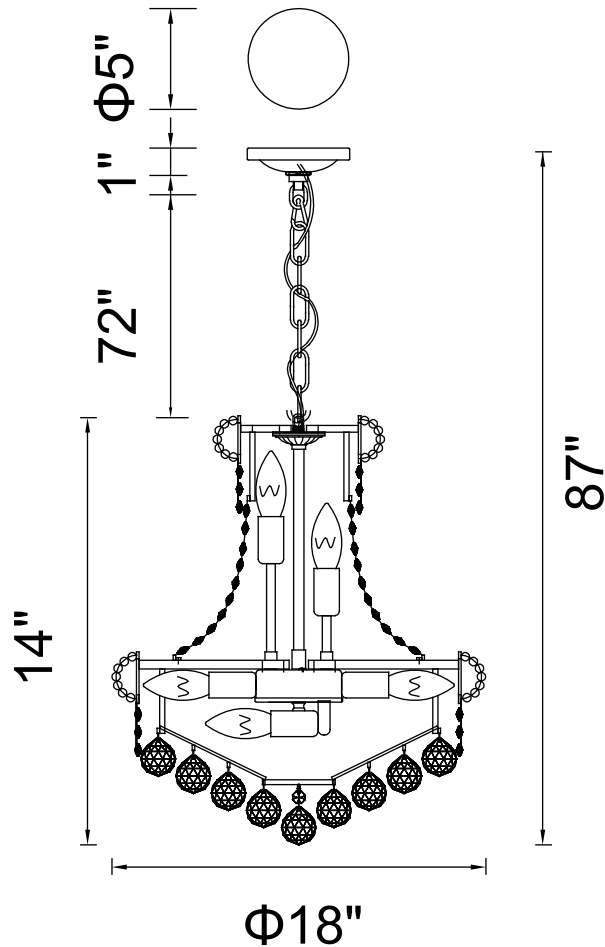

Item	8001P14G
Collection	EMPIRE
Finish	Gold
Glass	-----
Crystal	Clear
Input	120V AC,60HZ,AC

Shade	-----
Length/Dia.	18"
Width/Ext.	-----
Height	14"
Maximum	87"
Lumens	-----

Light Source	E12
Bulb Info.	6×60W
Included	-----
Dimmable	No
Color	-----
Weight	

CWILIGHTING
www.cwilighting.com
Info@cwilighting.com

140 Steelcase Rd.W.
 Markham ON. L3R 3J9 Canada
 Tel: 905 940 4999
 Toll: 1-877-564-6034
 Fax: 905-940-0126
 Toll Fax: 1-866-840-2796

Dallas showroom
 Dallas Market Center
 Showroom #: 3327
 2100N. Stemmons Frwy.
 Dallas, TX 75207

